

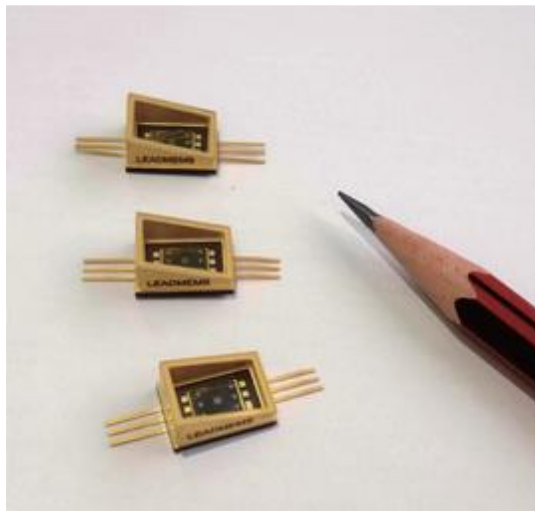

**Xi'an ZhiSENSOR
Technologies Co., Ltd.**

**C2110 Datasheet
V1.0**



C2110

MEMS mirror

Introduction

C2110 is a two-axis electrostatic driven resonant MEMS mirror with characteristics of high reliability, small size, and lightweight. The surface of the chip is covered with Au, which reflectivity for infrared light (wavelength $\geq 800\text{nm}$) over 95%.

Features		Applications	
	1 Electrostatic driven		1 Laser projectors
	2 Two axis		2 AR/VR
	3 Covered with Au		3 Machine vision
	4 Low consumption		4 Lidar
	5 Small size	
	6 High reliability		

MEMS Mirror Parameters

Item	Value	Unit
Diameter	1	mm
Maximum driven voltage	Fast axis:120	V
	Slow axis:35	V
Storage temperature	-40~85	°C
Operating temperature	0~70	°C

The Resonant Frequency and Working Voltage

Fast axis

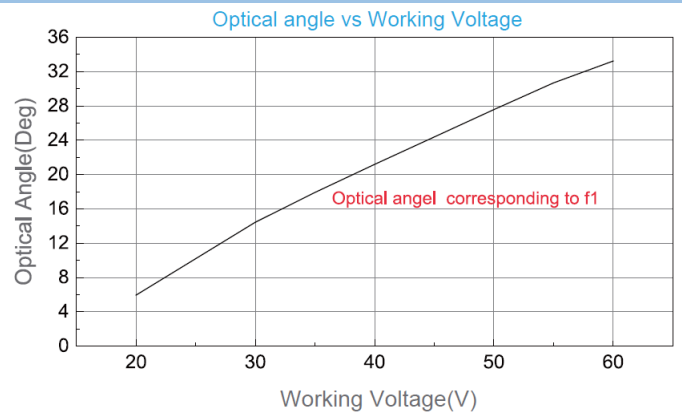
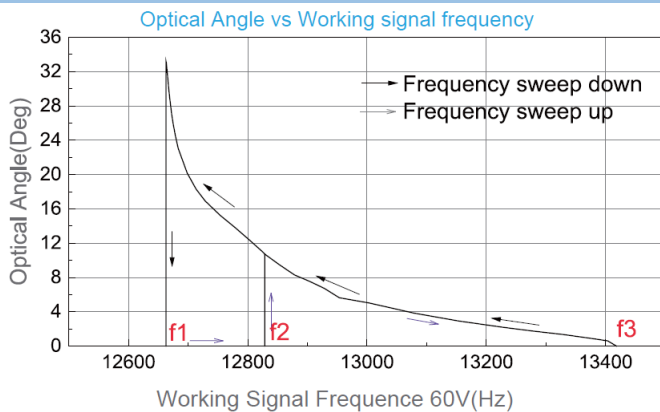

Slow axis

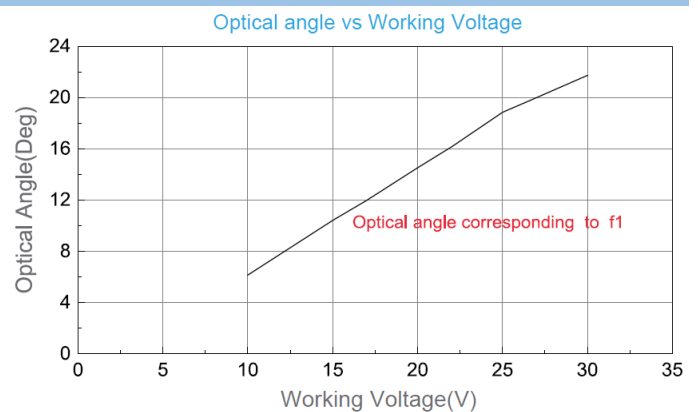
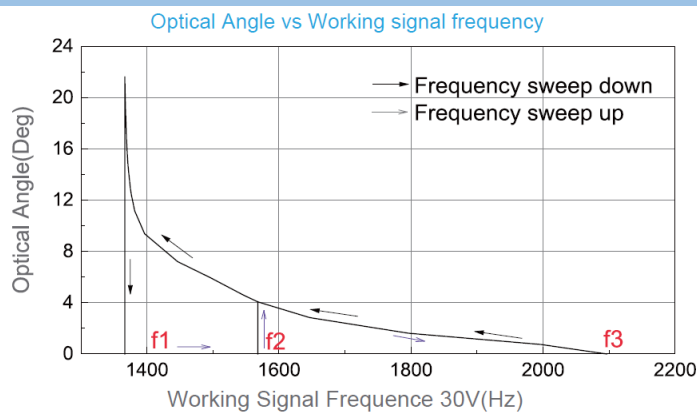

- Note: 1. The “working signal frequency” in the figure are resonant frequency of fast axis and slow axis;
2. The frequency response curve of each axis are difference between frequency sweep up and frequency sweep down.

MEMS Mirror Drive

Both axes of the C2110 are working in resonant state, and the torsional angle are related to the frequency and driven voltage, users can reference the frequency response curve of each axis for more information. Users must make sure the frequency of drive signal are between $f2*2$ and $f3*2$ (shown at the frequency response curve, and the value are list as below) for the MEMS mirror working steadily. Then change the frequency of the drive signal to the desired torsional angle (Keep in mind that the frequency of the drive signal is twice the resonant frequency).

Item		Working frequece	Corresponding drive signal frequency	Unit
Fast axis	f1	12700	25400	Hz
	f2	12850	25700	Hz
	f3	13200	26400	Hz
Slow axis	f1	1300	2600	Hz
	f2	1450	2900	Hz
	f3	2000	4000	Hz

Note: The frequency of the drive signal is twice the working frequency.

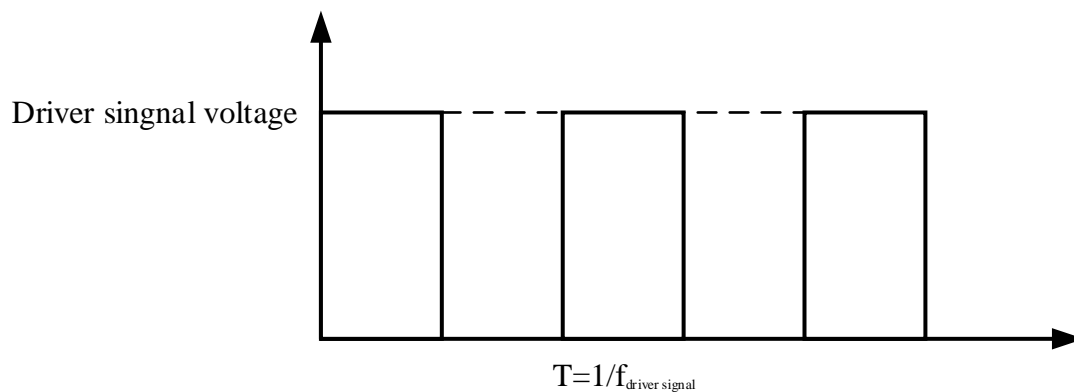

The driven voltage signals, added to the pins of C2110, are square wave as shown in the figure, which duty ration are 50%. The value of the voltage of the signal can reference to working voltage of each axes. Keep in mind that the frequency of the drive signal is twice the resonant frequency.

The following is the reference drive circuit of C2110.

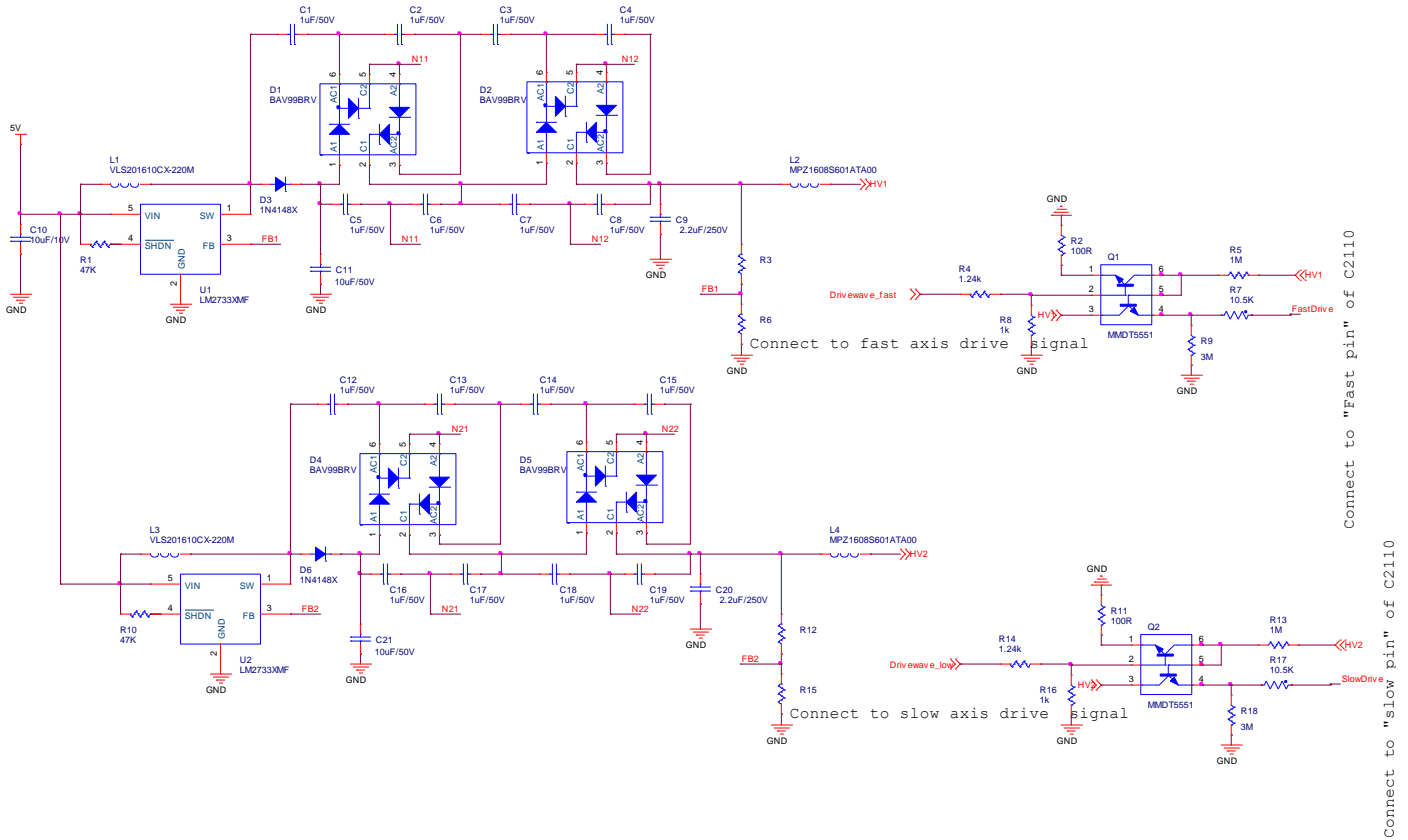

- Note: 1. HV1 and HV2 are the driving voltages of the chip's fast and slow axes, respectively;
 2. $HV1=1.23((R3/R6)+1)$, $HV2=1.23((R12/R15)+1)$;
 3. The reference circuit only includes boost circuit and switch circuit, the square wave signal are given by users.

Pin Configuration and Functions

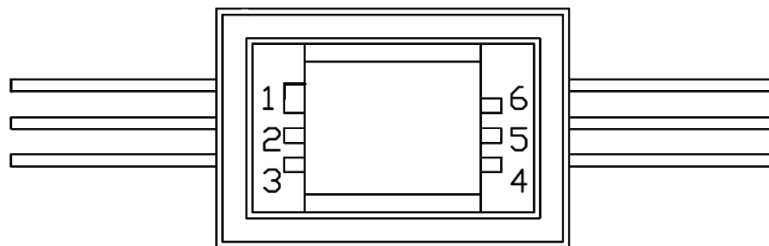

Pins of C2110

Functions of pins

NO.	Function	Description	Note
1	GND	-	-
2	GND	-	-
3	SLOW	Connect to "LowDrive"	
4	FAST	Connect to "FastDrive"	-

5	GND	-	-
6	SLOW	- Connect to "LowDrive"	-

Dimension of C2110

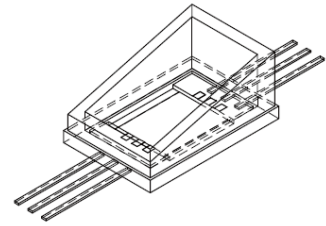
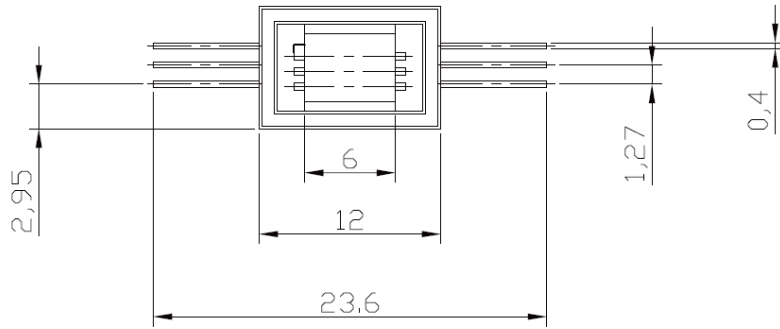
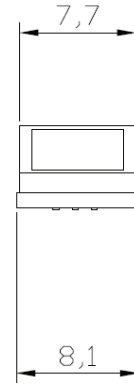
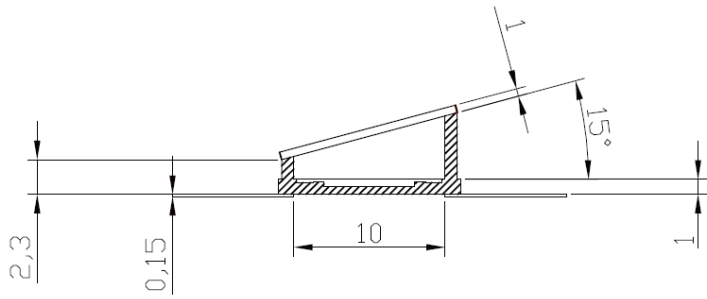

Unit: mm

Copyright by

Xi'an Zhisensor Technologies Co., Ltd.

All rights reserved.

The information in this document is subject to change without notice. No part of this document may in any form or by any means (electronic, mechanical, micro-copying, photocopying, recording or otherwise) be reproduced, stored in a retrieval system or transmitted without prior written permission from Xi'an Zhisensor Technologies Co., Ltd.